

Thule Yepp Nexxt Maxi

12080201, 12080202, 12080203,
12080204, 12080205

> Instructions



Carbon fiber frame

Min. load capacity: 25 kg / 55 lbs
Must comply to ISO11243

Ø 11-16 mm
Ø 0.43-0.63"

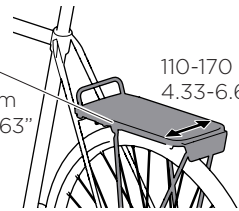

110-170 mm
4.33-6.69"



9-72 M
9-22 kg
20-48,5 lbs



EN 14344



ASTM F1625

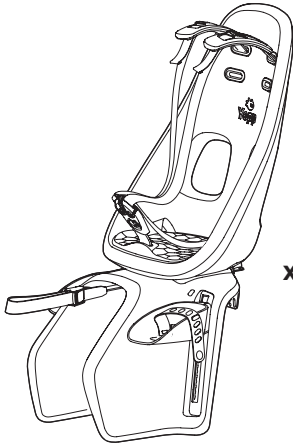

x1



x1

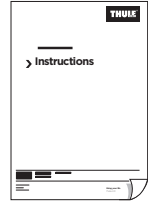

x1

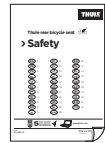

x1

1

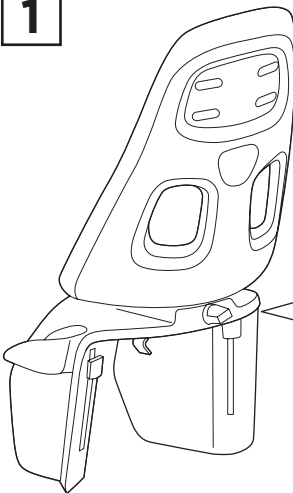

A

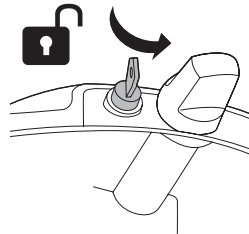

B

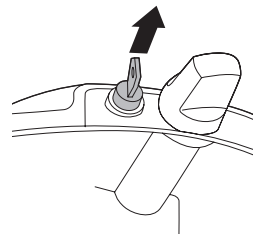

C

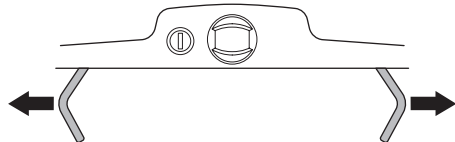
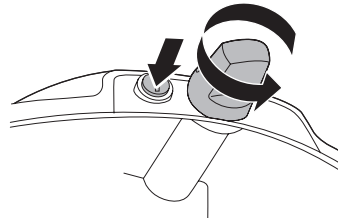

2

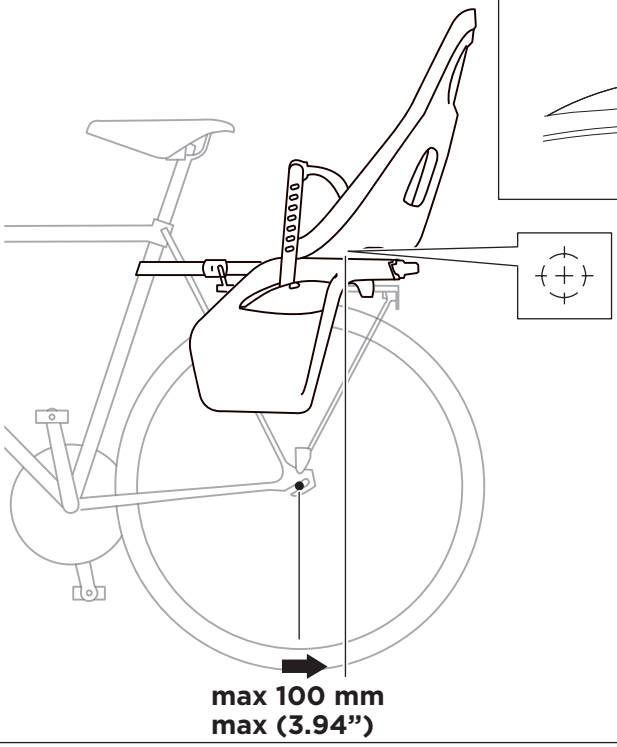
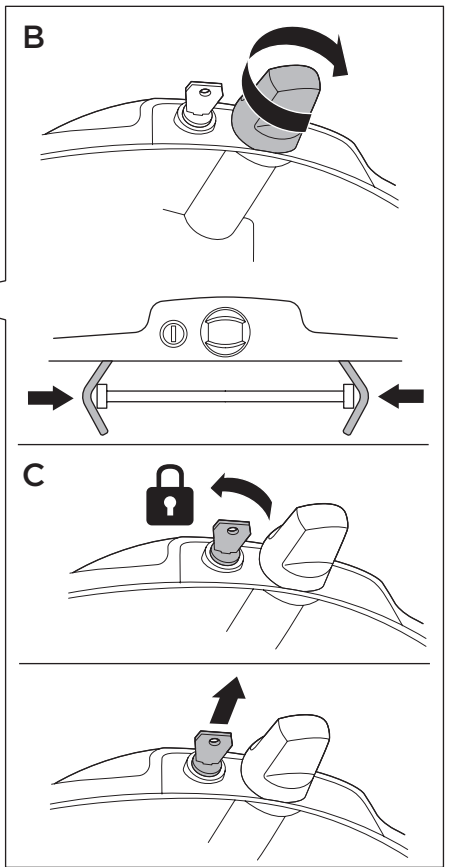
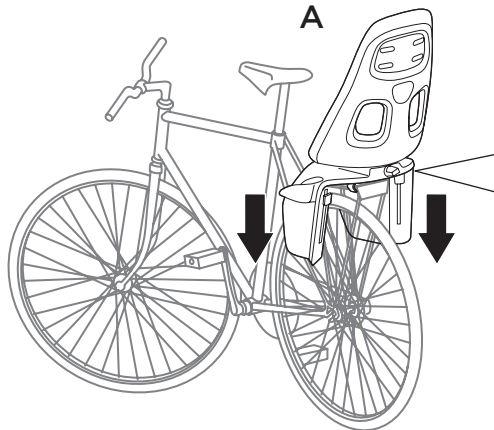

3

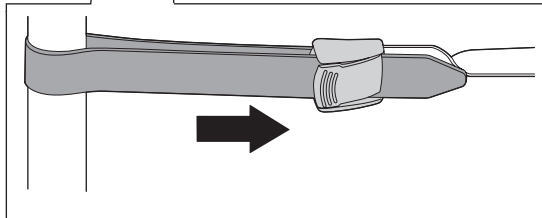
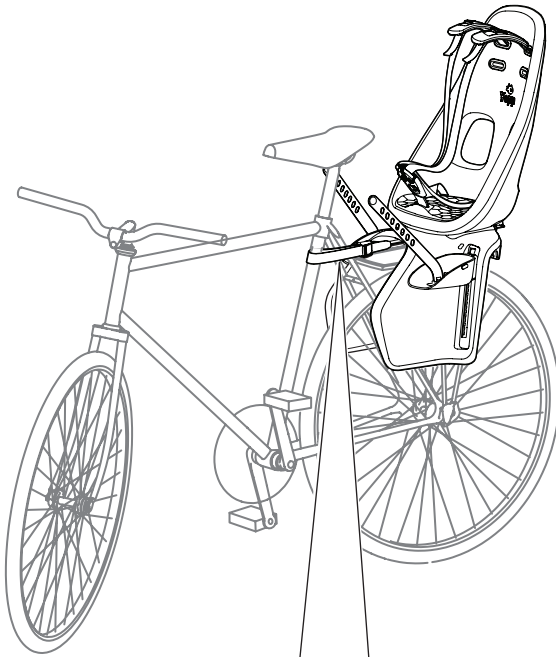

4

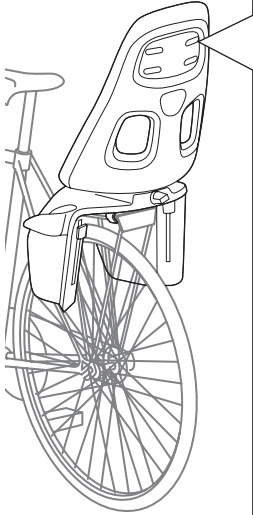

A

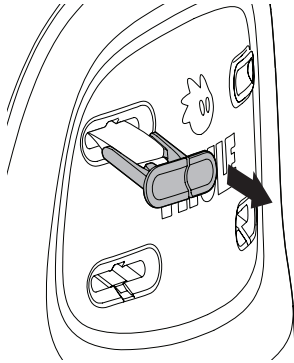

B

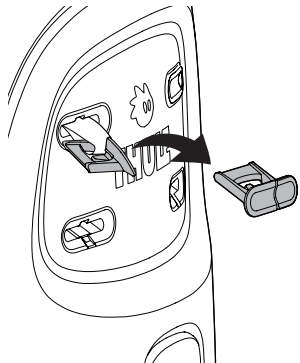

C

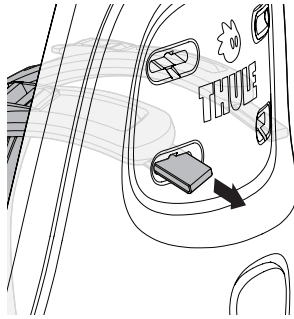

D

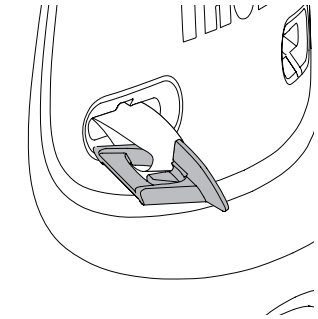

E

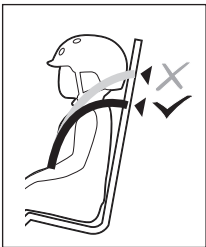
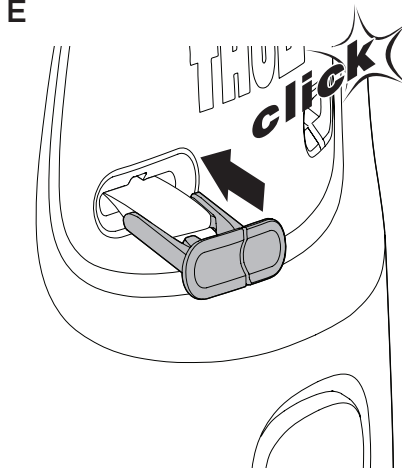

5

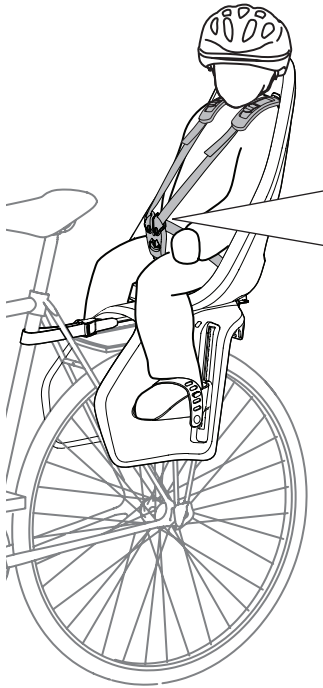

A

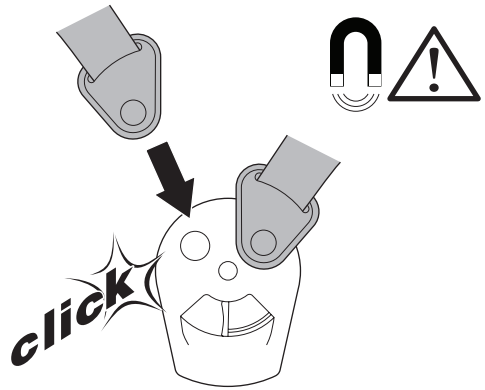

i

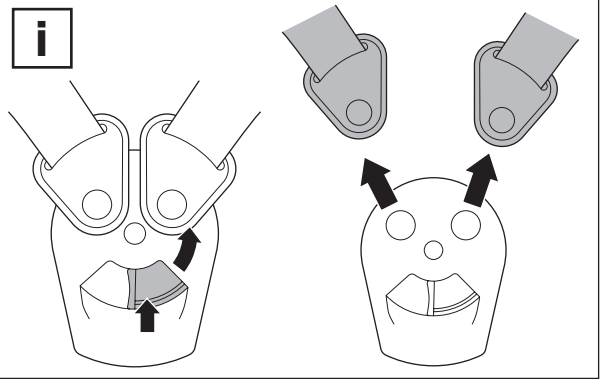

B

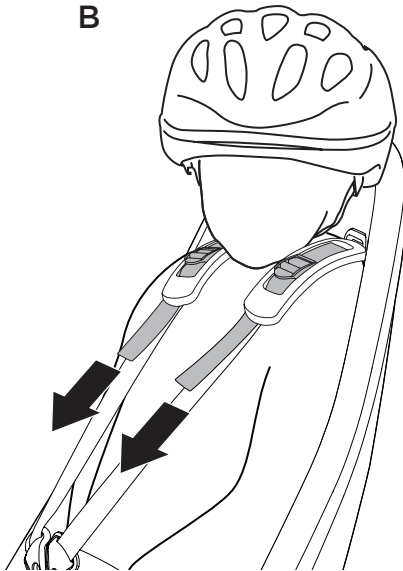

6

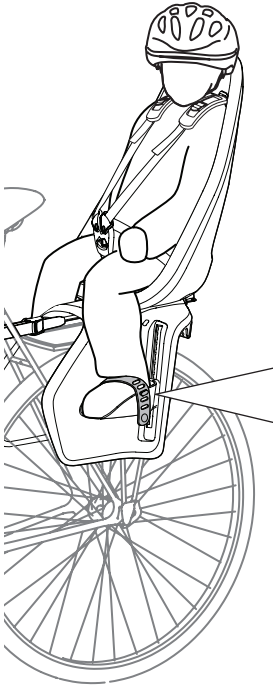

A

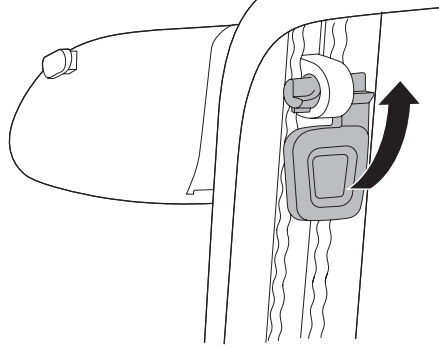

B

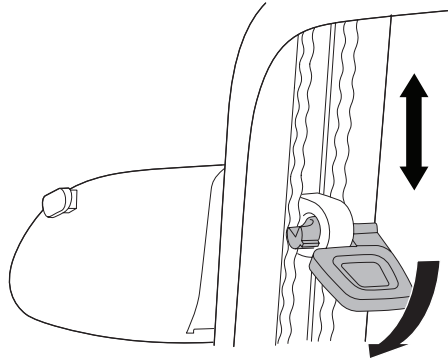

C

